

KNX

BACnet

MQTT

Modbus

Helvar

OPC
(DA/UA)

SNMP

Fidelio/Opera | Protel | Infor
RMS Cloud | CharPMS
VingCard Web | Kaba | Salto

DALI EnOcean
M-Bus DMX

Proprietary solutions

All-in-one

**Building management software for
medium-sized and enterprise building
automation projects**

Building automation systems

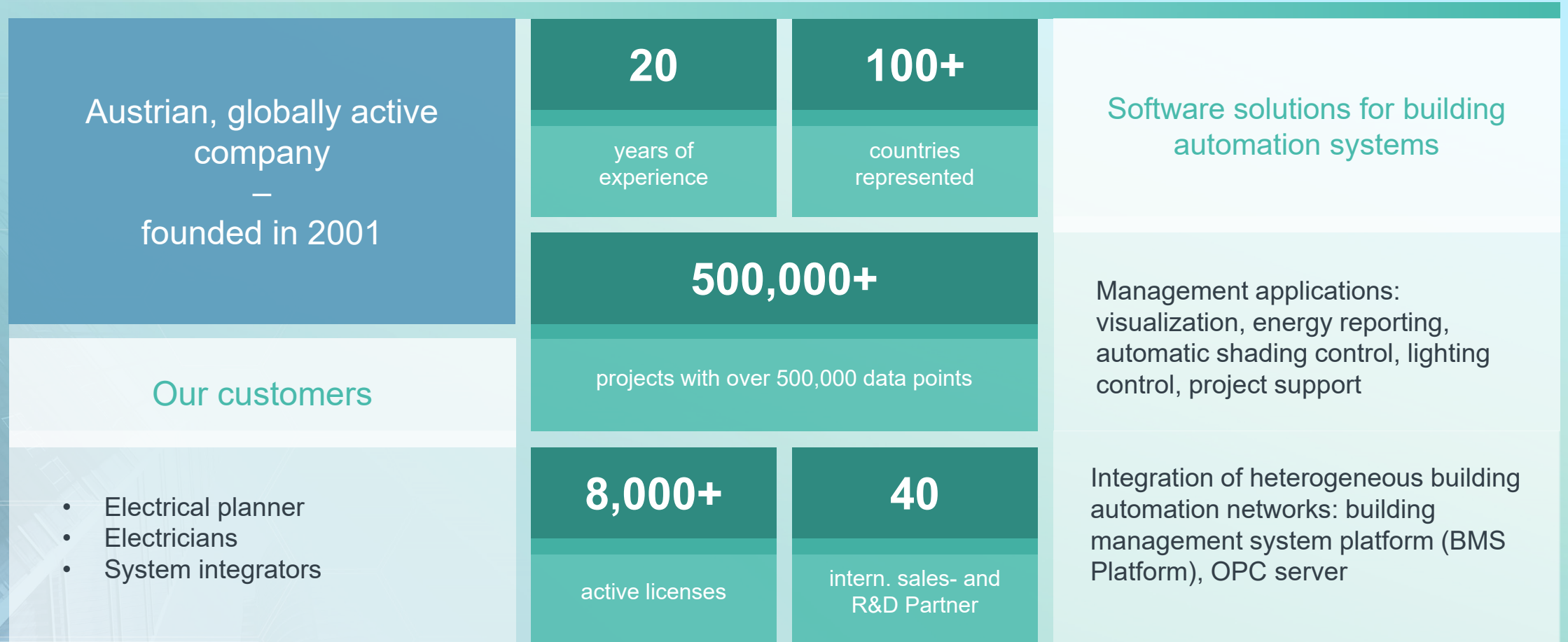

Building Automation Systems (BAS)

aim at improving control and management of mechanical and electrical systems in buildings

Modern BAS are distributed systems

where embedded devices are connected via computer networks to exchange information and data

Core application areas are lighting/shading and heating, ventilation, and air conditioning (HVAC)

Today other application domains are integrated too

- Security systems (access control, CCTV, security alarm systems, ...)
- Safety systems (fire alarm systems, water leakage detection, CO2 monitoring, ...)
- Smart metering and energy management systems
- ...

Building automation systems

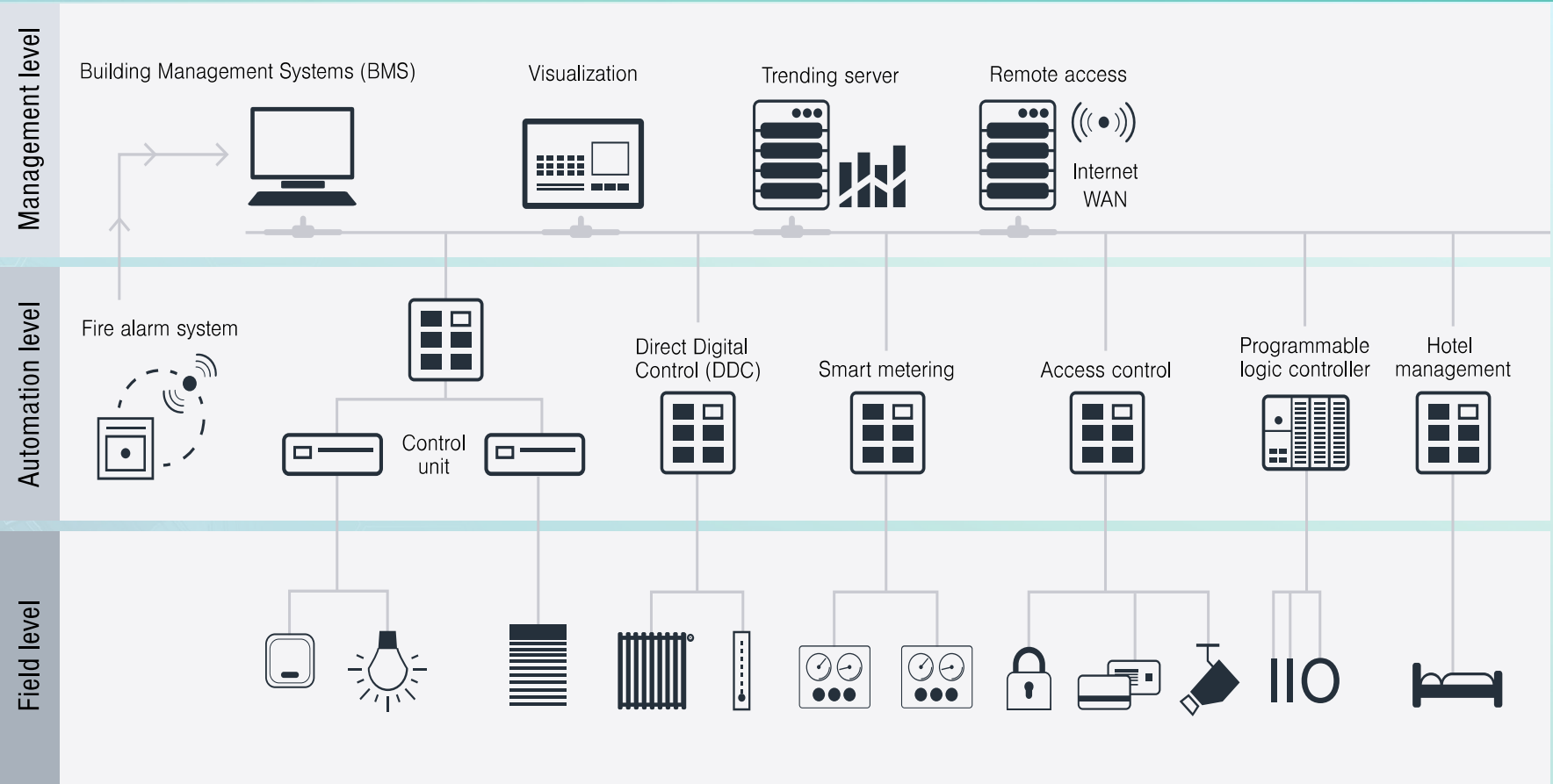

Building Management Systems (BMS) are located at the management level to provide management tasks

- Visualization, trending, remote access, alarm management, and other maintenance tasks
- Integration of different subsystems into “all-in-one” solution

Why building automation?

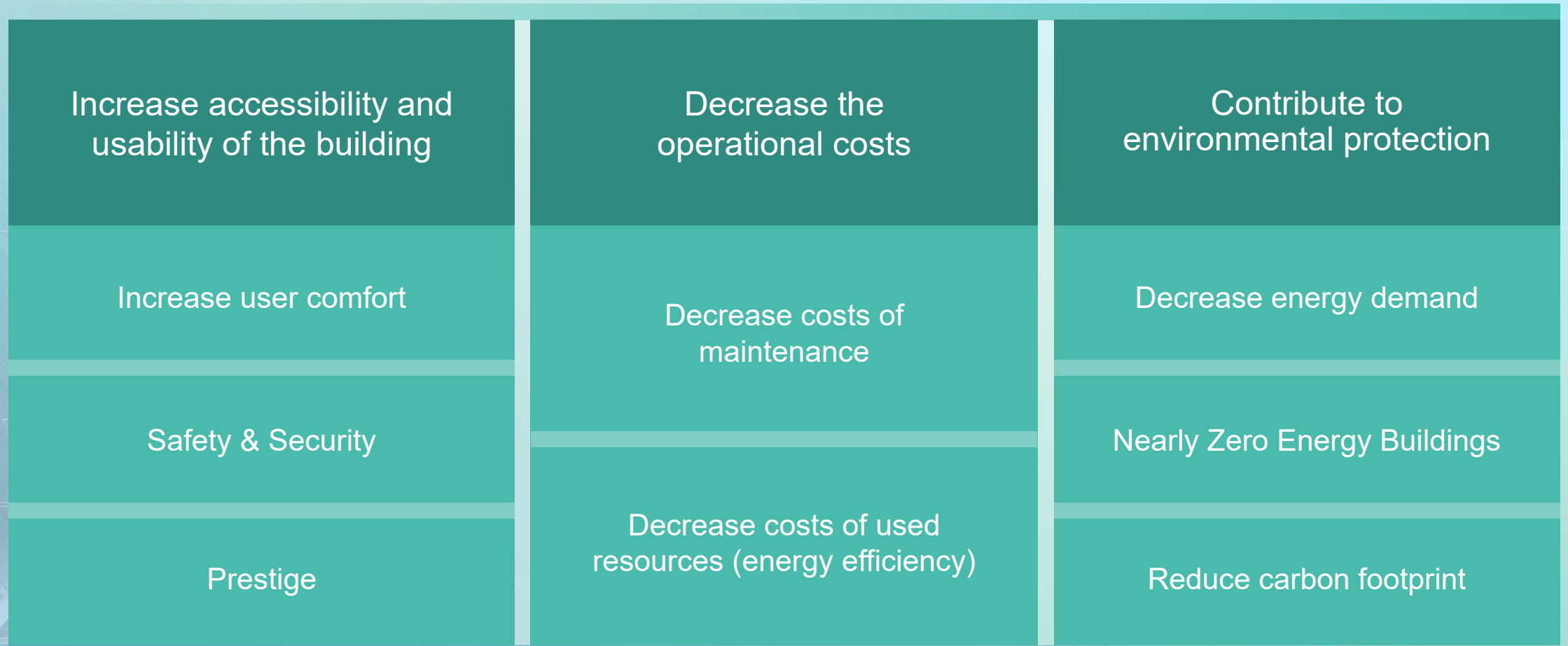

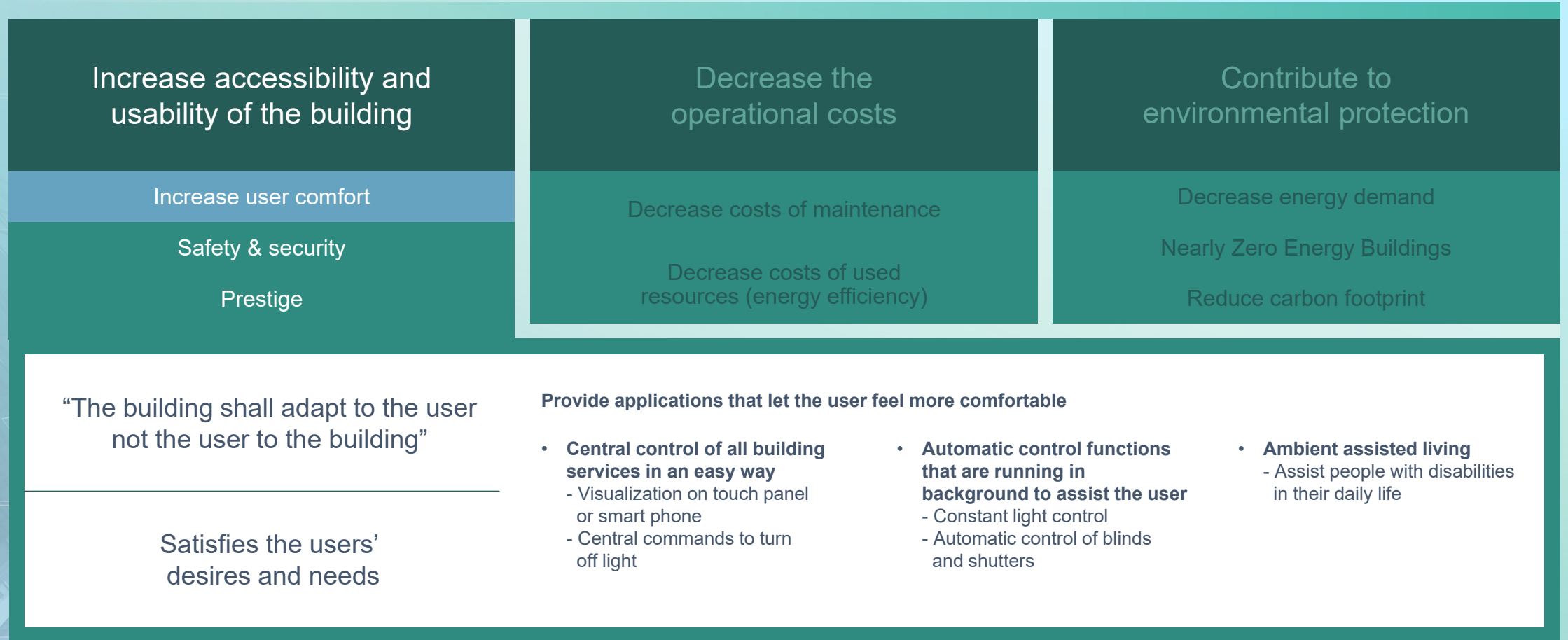

Increase accessibility and usability of the building

Increase user comfort

Safety & security

Prestige

Decrease the operational costs

Decrease costs of maintenance

Decrease costs of used resources (energy efficiency)

Contribute to environmental protection

Decrease energy demand

Nearly Zero Energy Buildings

Reduce carbon footprint

The user shall feel safe and secure within his/her home

Safety applications

- Fire alarm system
- Detection of broken light circuits
- Water leakage detection
- Remote monitoring and control of devices

Security applications

- Access control system
- Security alarm system
- CCTV systems
- Presence simulation

Increase accessibility and usability of the building

Increase user comfort

Safety & security

Prestige

Decrease the operational costs

Decrease costs of maintenance

Decrease costs of used resources (energy efficiency)

Contribute to environmental protection

Decrease energy demand

Nearly Zero Energy Buildings

Reduce carbon footprint

Additional social benefit

“My house, my car,
my building automation system”

Advanced applications

- Control your smart home/building from your smartphone
- Personalized visualization tailored to your desires

Use latest technologies

- Impress your guests with your smart home/building

Decrease operational costs

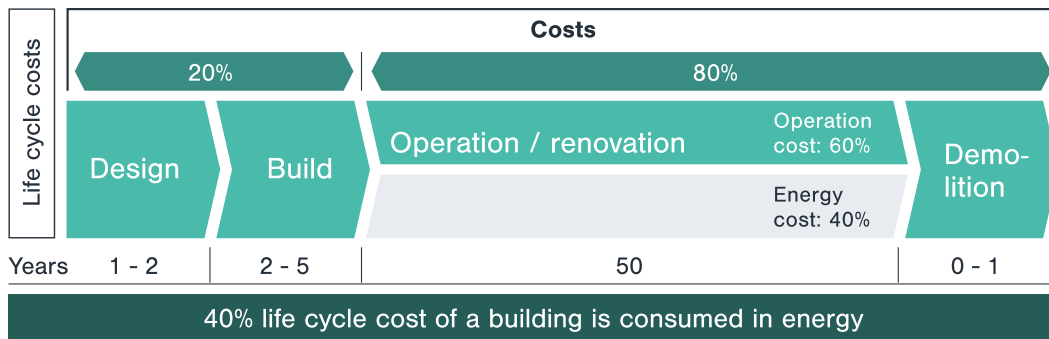

The life cycle of the building has to be considered

80% of overall costs are operational costs!

- Costs of maintenance
- Costs for energy and resources

Decrease operational costs of maintenance

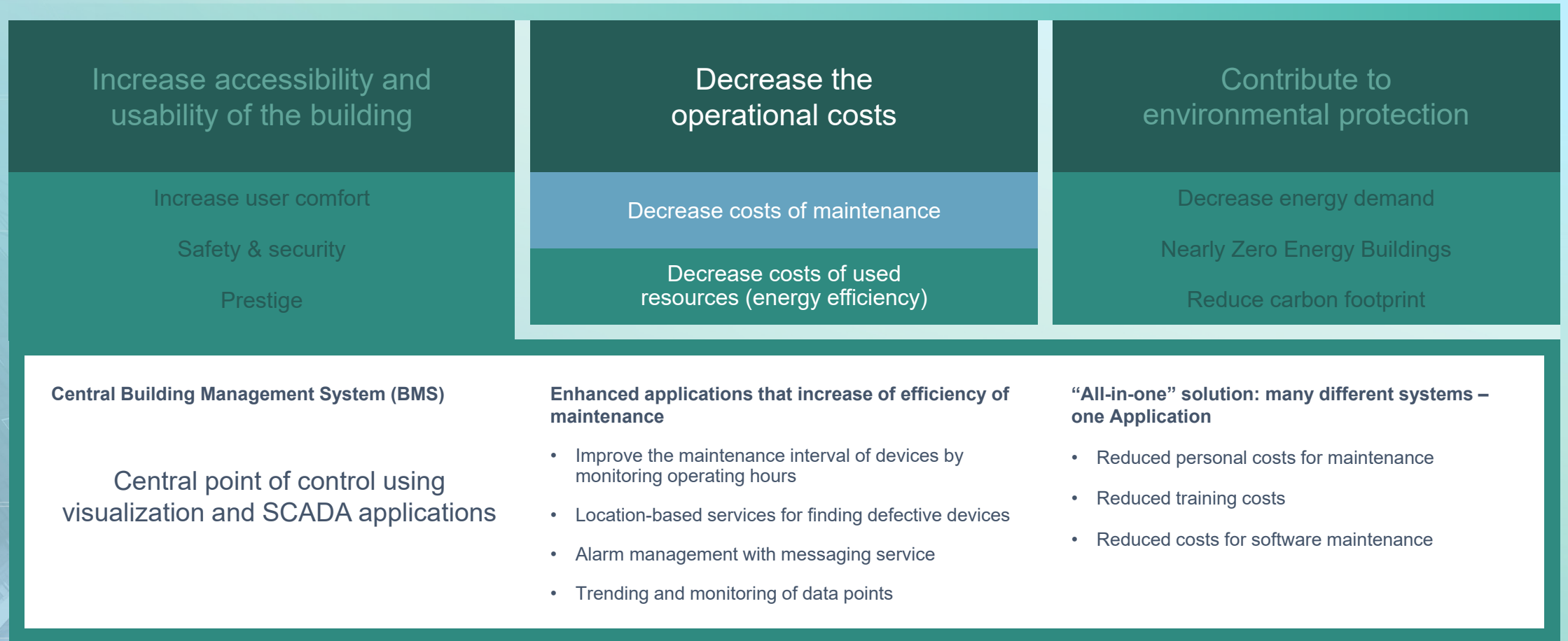

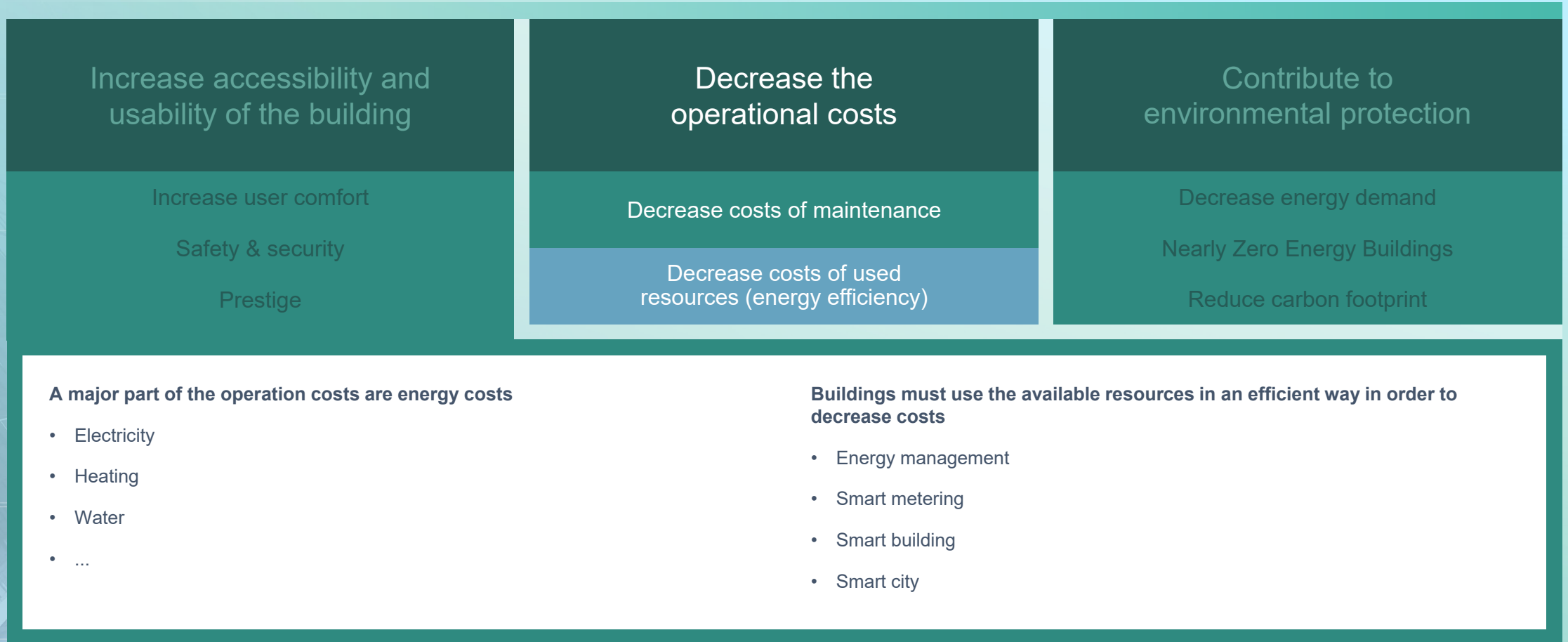

Increase accessibility and usability of the building

Increase user comfort

Safety & security

Prestige

Decrease the operational costs

Decrease costs of maintenance

Decrease costs of used resources (energy efficiency)

Contribute to environmental protection

Decrease energy demand

Nearly Zero Energy Buildings

Reduce carbon footprint



Today energy-efficient buildings are a must!

- Regulated by law!
- 2002/91/EU, 2010/31/EU: Energy performance of buildings directive
- EN-15232: Energy performance of buildings: Impact of building automation, controls, and building management
- Other directives and national regulations exist too

Modern buildings must be sustainable and energy-efficient

- Decrease energy demand
- Decrease carbon footprint
- Use renewable energy resources
- Nearly Zero Energy Building (NZEB)
- Nearly Zero Emission Building

EN 15232: Impact of building automation, controls, and building management

Defines different classes for energy performance of building

- A** Energy-efficient BAS with BMS
- B** Advanced BAS with special BMS functions
- C** Standard BAS
- D** Non efficient BAS

Class A and B are
not possible without
BAS and BMS!

Increase in the energy efficiency of buildings has two advantages

- Decrease the energy costs and thus the operational costs
- Contributes to environmental protection

How can the energy efficiency of building be improved?

$$C = \frac{D}{\eta}$$

C ... Consumption
D ... Demand
\eta ... Performance

Acting on the performance of
equipment and processes

$$C = \frac{D}{\eta \uparrow}$$

C ... Consumption

D ... Demand

n ... Performance

Use the best available technologies

- LED
- Substituting heating devices with poor efficiency
- Use ventilation systems (enthalpy recovery, ...)

Improving the consumption habits of the users

Use smart metering to show the user the actual consumption (know2reduce)

$$C = \frac{D \downarrow}{\eta}$$

C ... Consumption
D ... Demand
n ... Performance

Core application areas

Today other application domains are integrated too

Modern BAS are distributed systems

Get a high reduction of the demand actively

Depending on

- the real use (presence, schedules, special needs, ...)
- external conditions (temperature, light, humidity, ...)
- bioclimatic criteria (orientation, position of the sun, shadows)

$$C = \frac{D \downarrow \downarrow}{\eta}$$

C ... Consumption
D ... Demand
η ... Performance

Use BAS to provide enhanced applications that decrease the demand actively

- Key component is BMS that has global view of all subsystems, devices, and data
- Integration of subsystems and aggregating data and information to provide advanced applications

Enhanced applications: examples

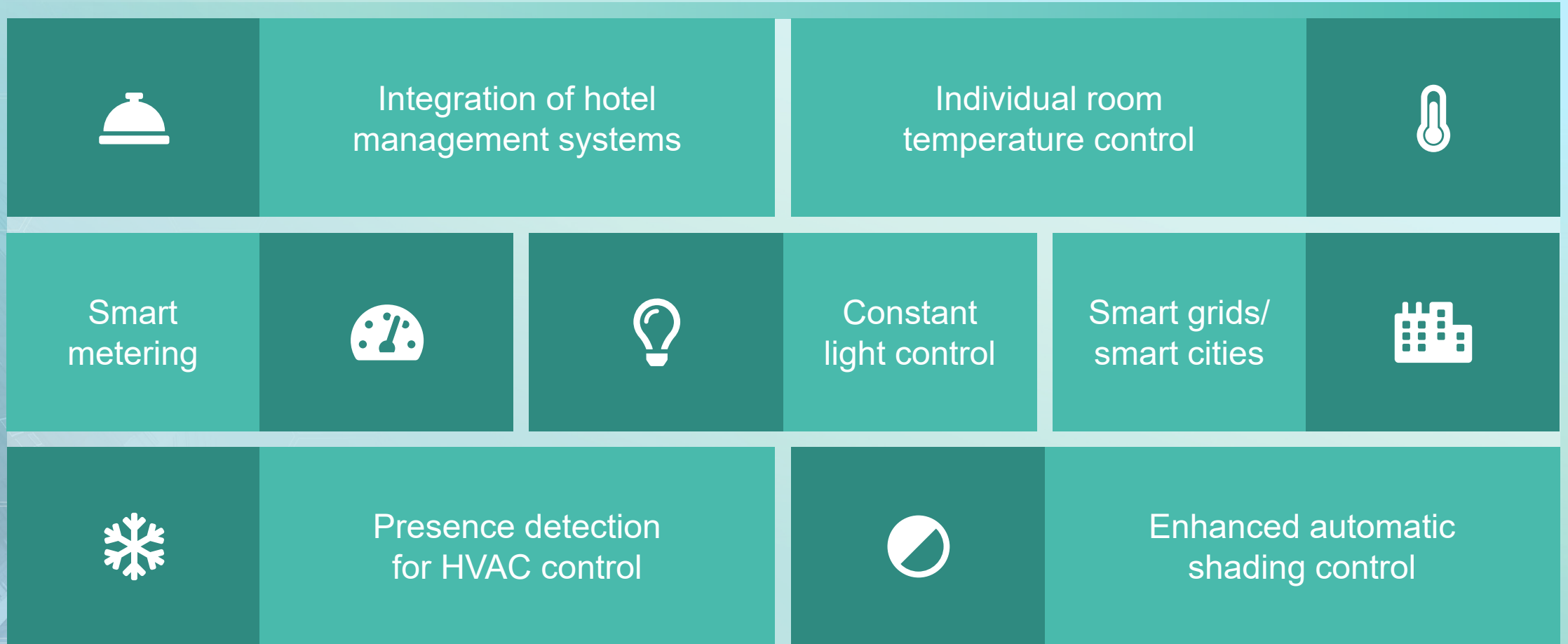

Constant light control

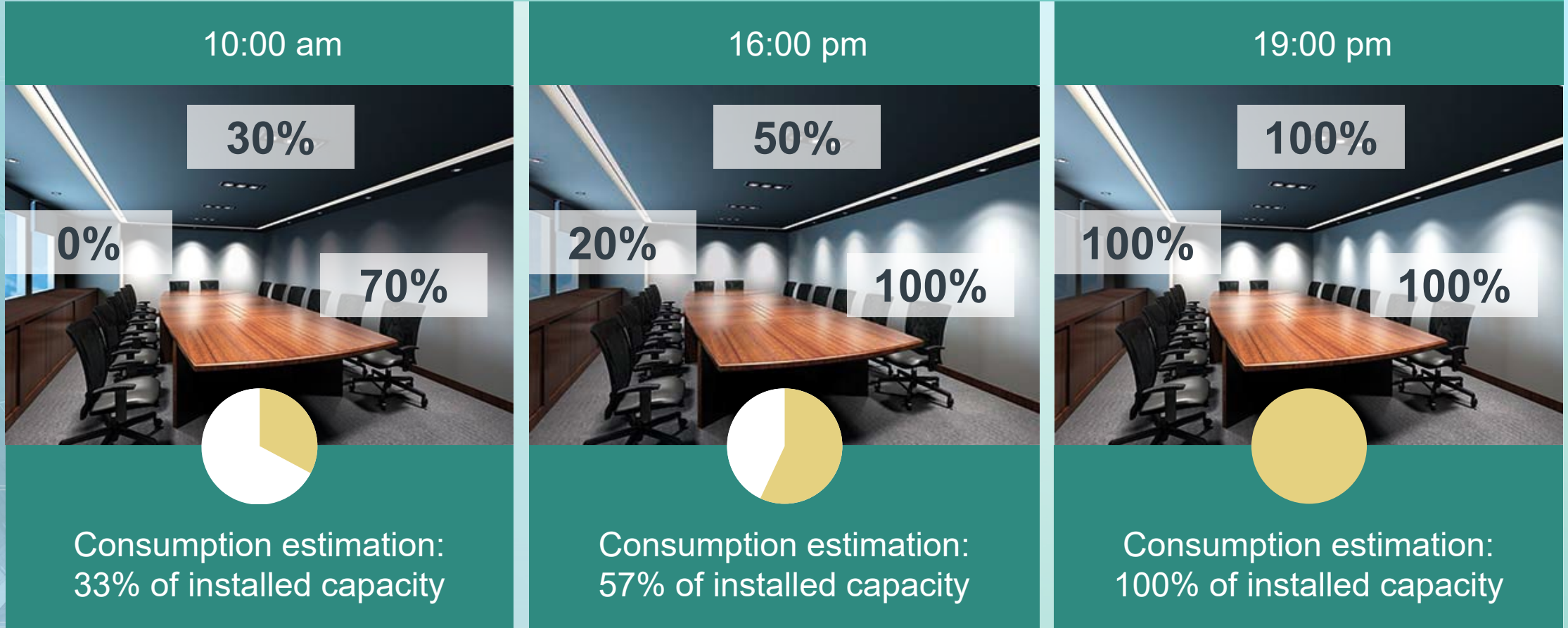

In 14 hours (8:00 am to 22:00 pm) only 55% of the installed power used

Presence detection
as additional input

Decreases energy consumption
(between 30% and 40% of savings)

Increases user comfort

Required for Class A

Individual room temperature control

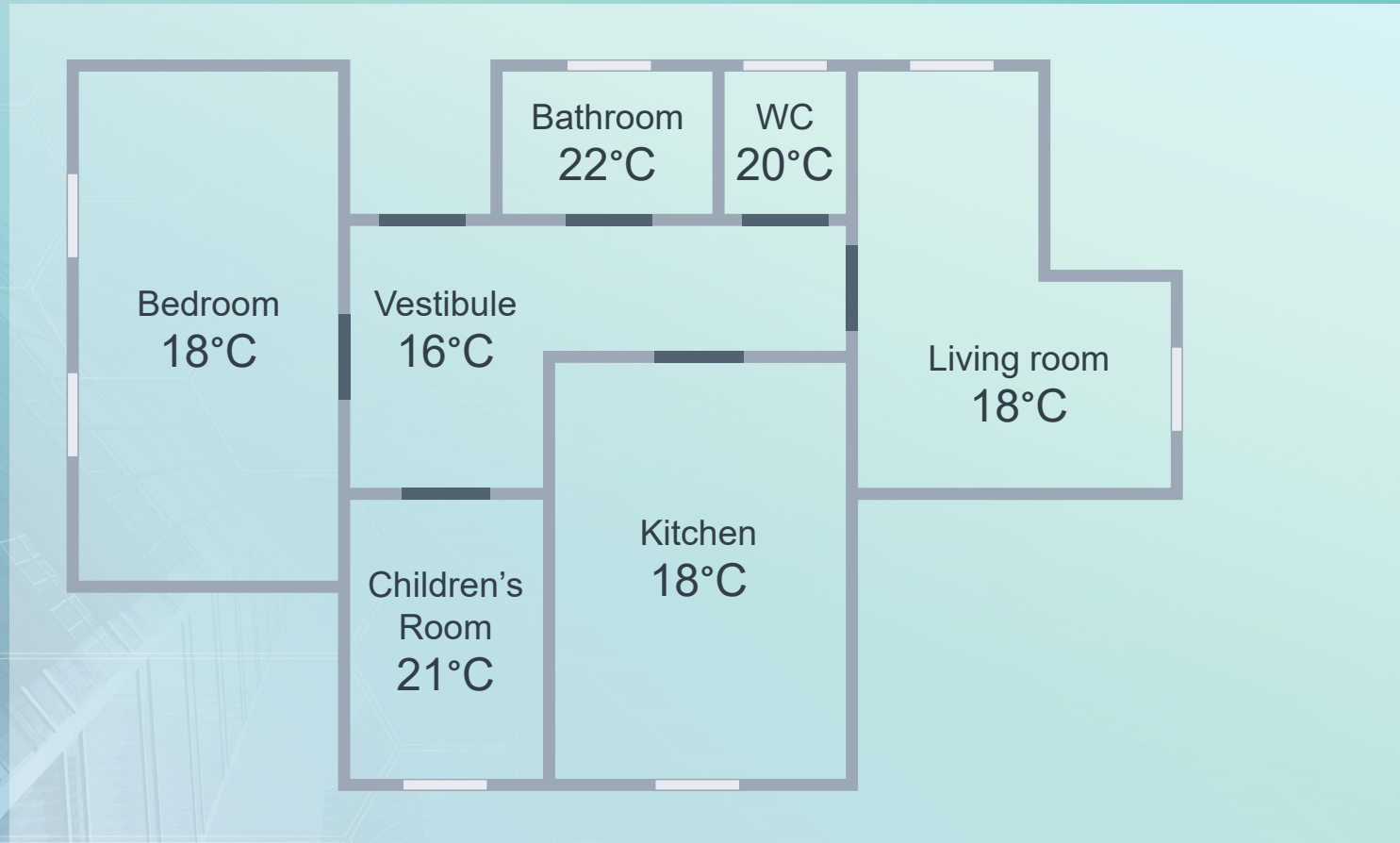

Decreases energy consumption
(about 30% of savings)

Increases user comfort
(each habit can set
its own set point)

Required for Class B

Presence detection for HVAC control

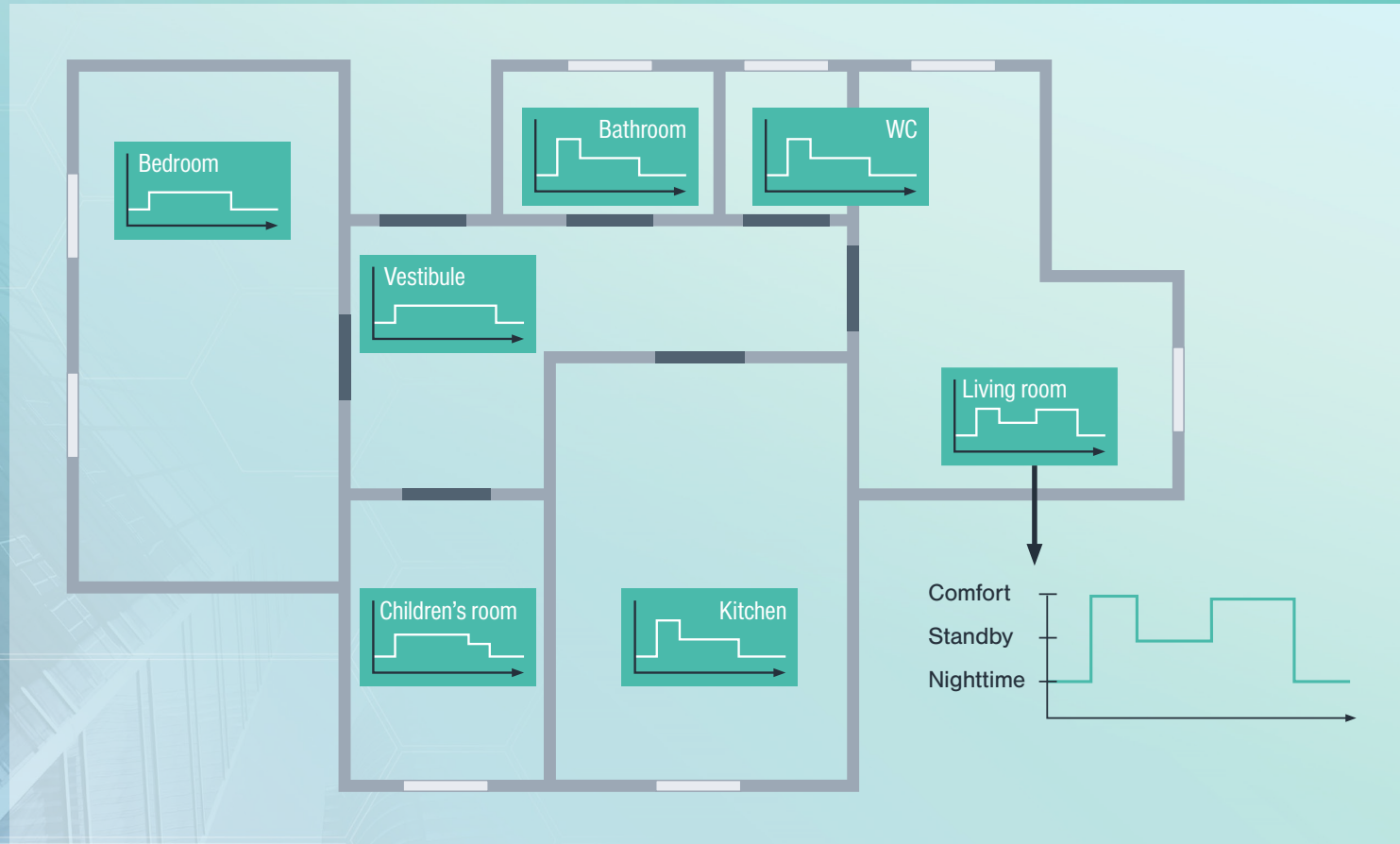

In addition to individual room control

Presence (or even amount of people) within a room controls the HVAC system

- Presence detector of lighting control can be reused

Required for Class A

NETx Shutter Control - enhanced automatic shading control

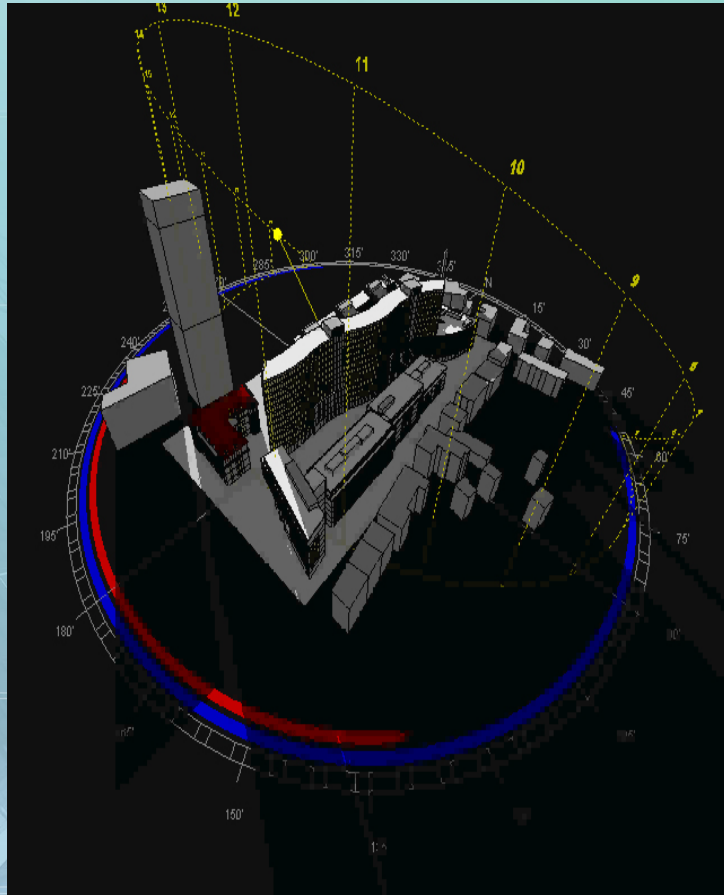

3D model of building + neighbor building and surrounding environment

Simulation to calculate optimal position of blinds and their slats

Current weather data + additional inputs are used together with simulated data to control blinds in real time

Decreases energy demand for HVAC system

Increases user comfort

Required for Class B and Class A

Check-in/check-out information can be used to control HVAC system of hotel rooms

- Check-in -> HVAC control is set to “Comfort Mode”
- Check-out -> HVAC control is set to “Eco Mode”

Decreases energy consumption

Increases user comfort

Measurement of the consumption value of the used energy resource is the basis for all energy management applications

- Monitoring for smart metering data (improving the consumption -> know2reduce)
- Analysis and comparison of smart metering data (identifying saving measurements, cost calculation)
- Reacting on smart metering data (e.g. load balancing)

Smart metering data is important input for smart grids

Integration of different technologies, systems, and application domains

Interconnection via Wide Area Network
(WAN)

Interact with smart grid,
offer interfaces to the grid

Focus on the total building
environment (NZEB, ..)

Involve all field which effect
living, citizens, ...

Challenges for providing BMS solutions

Enhanced applications can only be provided if all subsystems are connected to BMS

- Integration is of utmost importance

Building automation systems are Heterogeneous

- Many different technologies are used
- Each technology has its characteristics and its own way to represent and process control data
- Integration is a complex task

Sophisticated BMS solution is necessary

BMS is mandatory for Class B and Class A of EN 15232

Building Automation

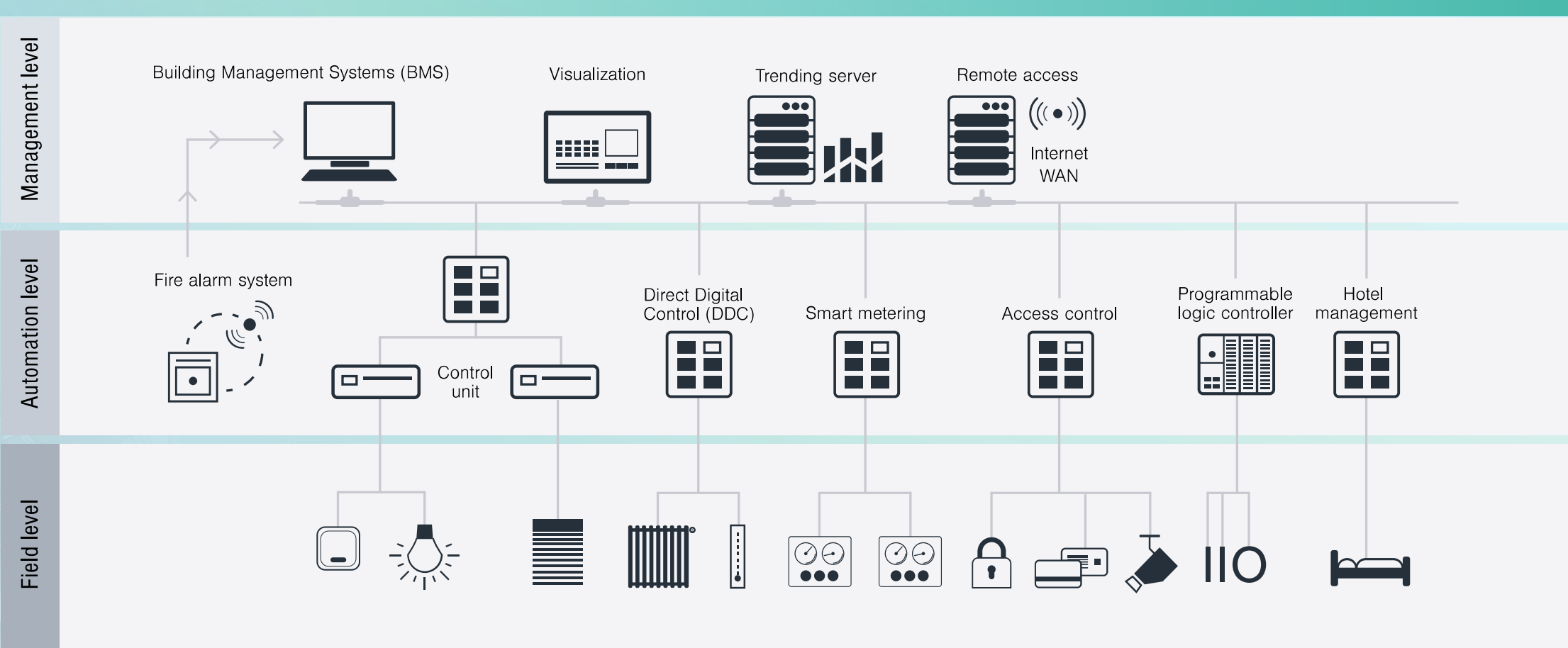

Management level

Building Management Systems (BMS)

Visualization

Trending server

Remote access



Internet
WAN

How to integrate management applications e.g. visualization, trending, alarm management, ...?



Direct Digital Control (DDC)



Smart metering



Programmable logic controller
Hotel management

M-Bus, DALI, Helvar, EnOcean, Fidelio/Opera, VingCard, ...
Other open and proprietary technologies

Field level



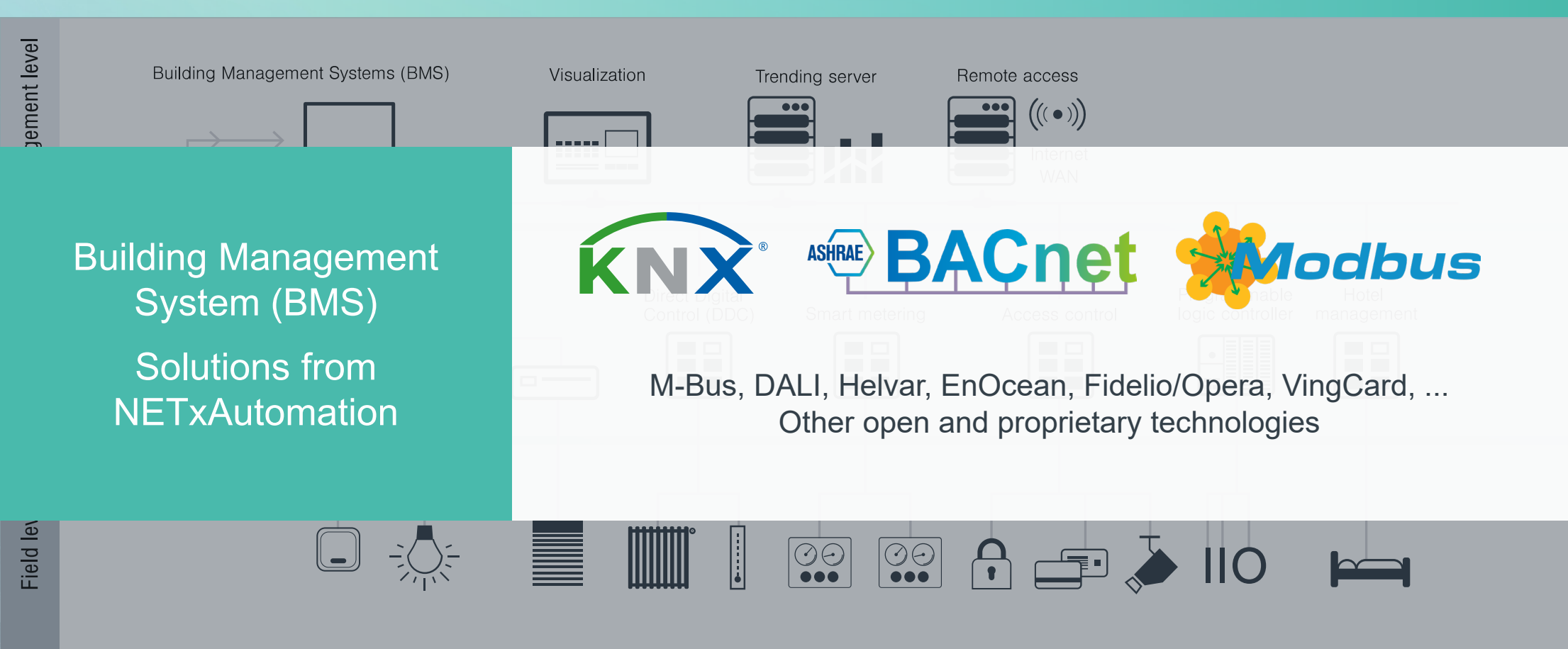

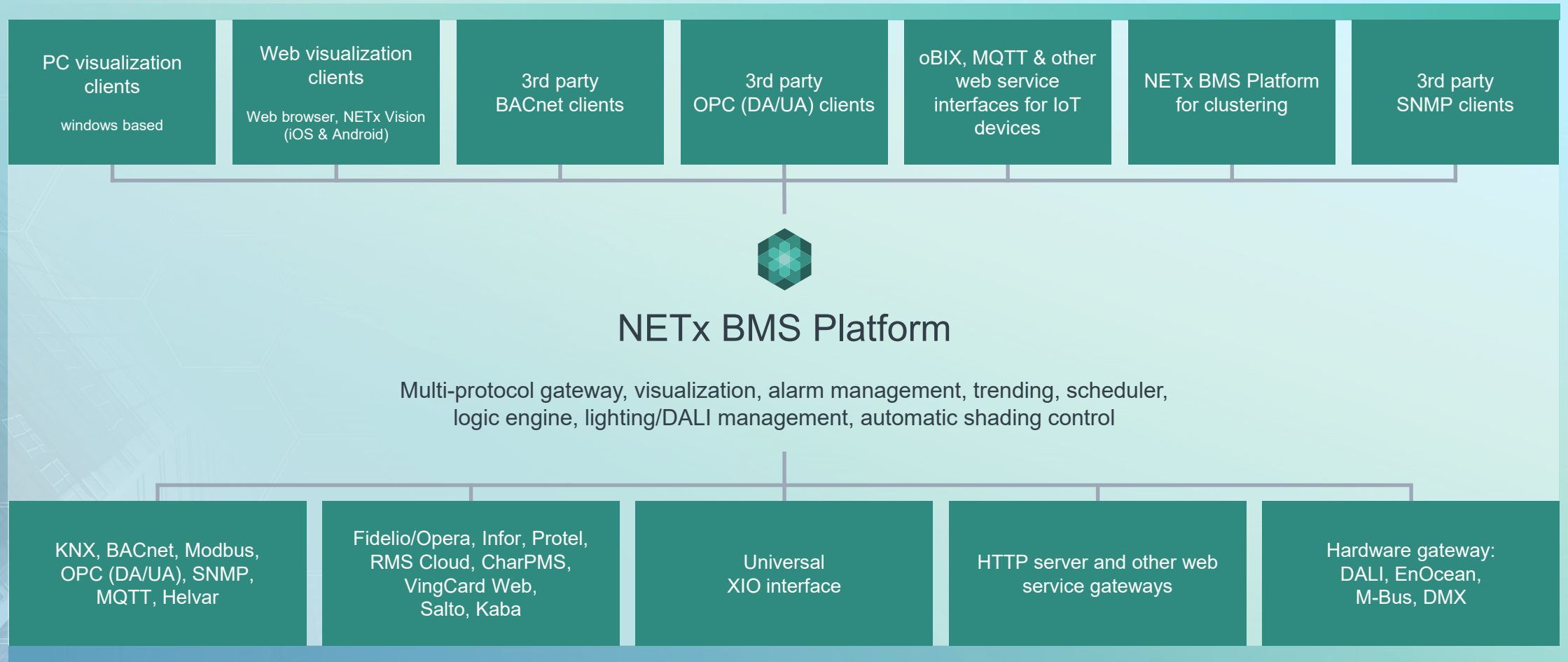

www.netxautomation.com